

IDMD-24-D-12.00-G

(2.54 mm) .100"

# SLIM BODY FLAT RIBBON IDC CABLES

## SPECIFICATIONS

For complete specifications see [www.samtec.com?IDSS](http://www.samtec.com?IDSS), [www.samtec.com?IDSD](http://www.samtec.com?IDSD), [www.samtec.com?IDMS](http://www.samtec.com?IDMS) or [www.samtec.com?IDMD](http://www.samtec.com?IDMD)

**Insulator Material:**  
Black Glass Filled Polyester  
**Plating:**

Au over 50 μm (1.27 μm) Ni or Sn over 100 μm (2.54 μm) Cu or 50 μm (1.27 μm) Ni

**Wire:**  
28 AWG 7/36 stranded  
Tinned Copper

**Temperature Range:**  
-20 °C to +105 °C (Rainbow Cable)  
-40 °C to +105 °C (Gray Cable)

**Contact (IDSS/IDSD):**  
BeCu

**Terminal (IDMS/IDMD):**  
Phosphor Bronze

**Current Rating (IDSD/TST):**  
3.4 A per pin  
(2 pins powered)

**Current Rating (IDMD):**  
3 A per pin  
(2 pins powered)

**Lead Size Range:**  
(0.56 mm) .022" SQ to (0.71 mm) .028" SQ

**Lead Insertion Depth:**  
(5.59 mm) .220" to (6.22 mm) .245"

**RoHS Compliant:**  
Yes

## RECOGNITIONS

For complete scope of recognitions see [www.samtec.com/quality](http://www.samtec.com/quality)



### Mates with:

TSW, MTSW, TSM, EJH, PHT, HMTSW, HTSW, HW, DW, EW, ZW, MTLW

### IDSD Mates with:

TST, HTST, ZST, BST, EJH

**IDM**  
= Standard Tail Male Plug

**IDS**  
= Socket

**TYPE STRIP**

**ROW OPTION**

**NO. PINS PER ROW**

**END ASSEMBLY**

**S**  
= Single

**D**  
= Double  
(Color coded cable N/A for 31 thru 36 pins/row. See -G option.)

**-S** = Single End

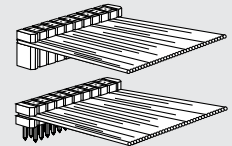

Socket or Male Plug on one end

**-D** = Double End

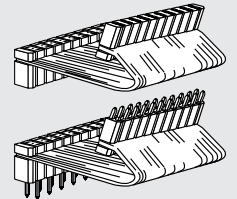

Socket or Male Plug on each end

**-T** = Transfer End

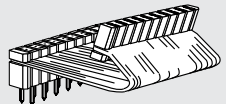

Male Plug on one end with socket on other. **Begin part number with IDM.**

## -02 thru -32

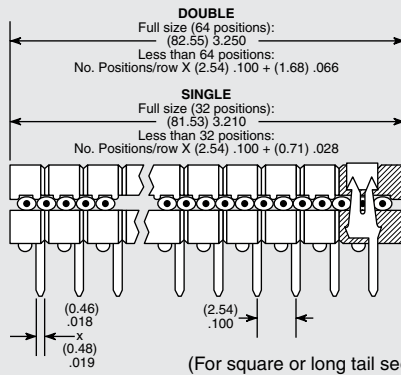

**IDMS (Single)**      **IDMD (Double)**

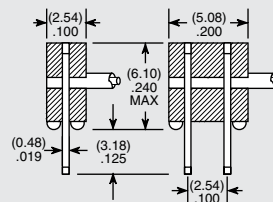

## -02 thru -36

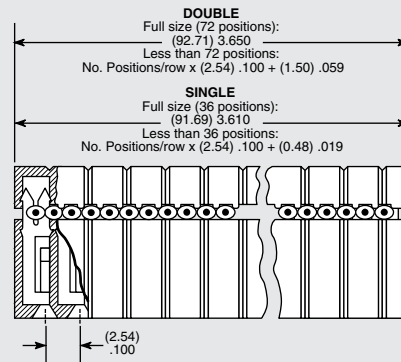

**IDSS (Single)**      **IDSD (Double)**

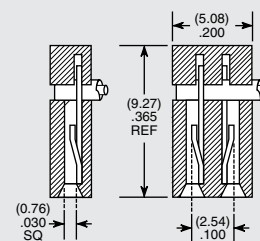

## OTHER SOLUTIONS

### Molded-To-Position IDC Assemblies

- Low profile
- Skinny side locks
- Dual beam contacts
- Single and double row
- (3.05 mm) .120" and (5.84 mm) .230" length tail available

Call Samtec for HCXX Series.

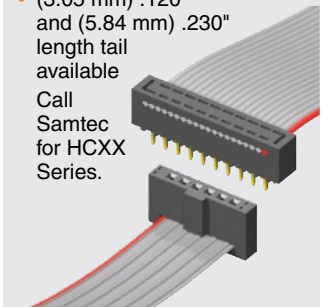

Due to technical progress, all designs, specifications and components are subject to change without notice.

[WWW.SAMTEC.COM](http://WWW.SAMTEC.COM)

All parts within this catalog are built to Samtec's specifications. Customer specific requirements must be approved by Samtec and identified in a Samtec customer-specific drawing to apply.

**Note:**  
This Series is non-standard, non-returnable.

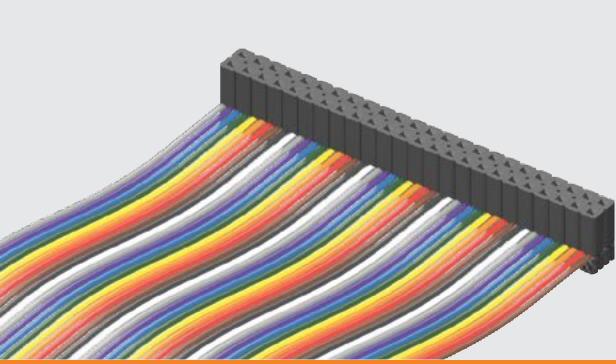

IDSD-24-S-05.00

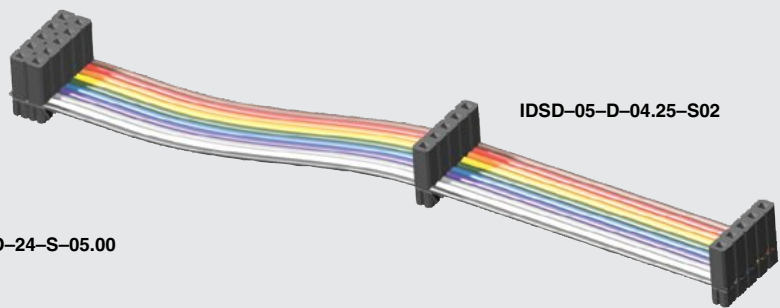

IDSD-05-D-04.25-S02

**IDSS, IDSD, IDMS, IDMD SERIES**

**ASSEMBLED LENGTH**

— “XX.XX”  
= Assembled Length

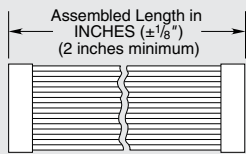

**OPTION**

**POLARIZING KEY**

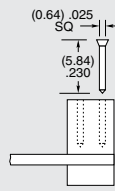

Optional polarizing key for use with IDSS & IDSD Series. Also polarizes SSW, SSQ, ESW & ESQ Series. Black High Temperature Thermoplastic

Order: Part Number PK-01-06  
(Available in wheels of six each)

**EJECTOR HEADERS & LOCKING CLIPS**

**RUGGEDIZED**  
— BY SAMTEC —

- Ejector headers
- Locking clips

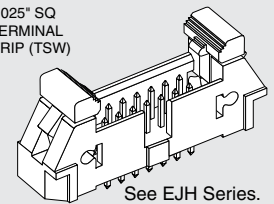
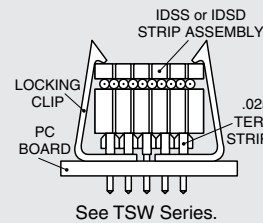

—T = Tin Plating (Both ends)

—C = Tin IDM  
= 10  $\mu$ " (0.25  $\mu$ m) Gold IDS  
(-T End Assembly Required)

—A = 10  $\mu$ " (0.25  $\mu$ m) Gold IDM  
= Tin IDS  
(-T End Assembly Required)

Standard plating is selective gold over BeCu contact for IDS; Selective gold over phosphor bronze for IDM.

1

—ST “X”  
= Stripped & Tinned

Specify Suffix from table. All dimensions are  $\pm 1/16"$ . Not available in 28 positions and higher.

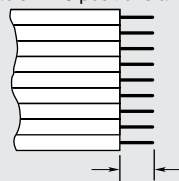

4

—S “XX”  
= Daisy Chain Single

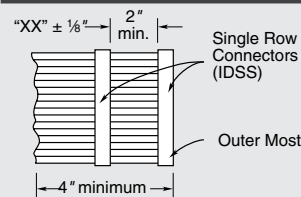

When mating double row connector with two single row connectors, the outer most single will be connected to Conductor #1 and the inside single to Conductor #2.

7

—R  
= Reversed

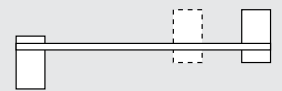

8

—P “XX”  
= Polarized

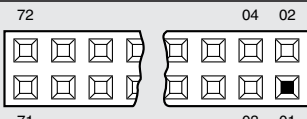

Specify “XX” as position. For Double the same position will be polarized on both ends. (Not available on IDM unless transfer, then only the socket is polarized.)

2

—G  
= Gray Cable

Specify -G for Gray cable. Gray cable has one red edge. IDSS and IDMS uses .100" centerline cable. IDSD and IDMD uses .050" centerline cable. Cable is 28 AWG 7/36 copper wire. Standard cable is same as above except color coded.

3

—B “XX”  
= Breakout

Specify “XX” as number of conductors to be broken out.

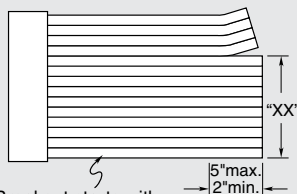

Breakout starts with Number 1 lead indicated by brown wire or red stripe. Shown on top side.

5

—D “XX”  
= Daisy Chain, Double

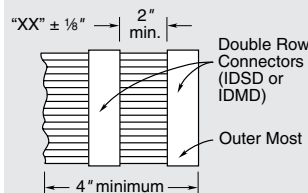

7

—W “XX”  
= Wiring Reversed Daisy Chain, Single

Same as -S “XX” except outer strip connected to Conductor #2 and inside strip connected to Conductor #1.

7

—M  
= Middle Reversed

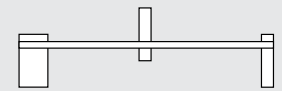

Requires -SXX, -WXX or -DXX

8

—O  
= Outside Reversed

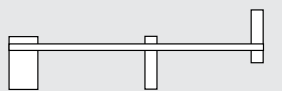

Requires -SXX, -WXX or -DXX

8

—RW  
= Reversed Wiring

#1 wire opposite position #1.

6

Due to technical progress, all designs, specifications and components are subject to change without notice.

[WWW.SAMTEC.COM](http://WWW.SAMTEC.COM)

All parts within this catalog are built to Samtec's specifications. Customer specific requirements must be approved by Samtec and identified in a Samtec customer-specific drawing to apply.